

Connection hoses and cables	
Water hose:	✓
Waste water hose:	✓
Electric cable:	✓

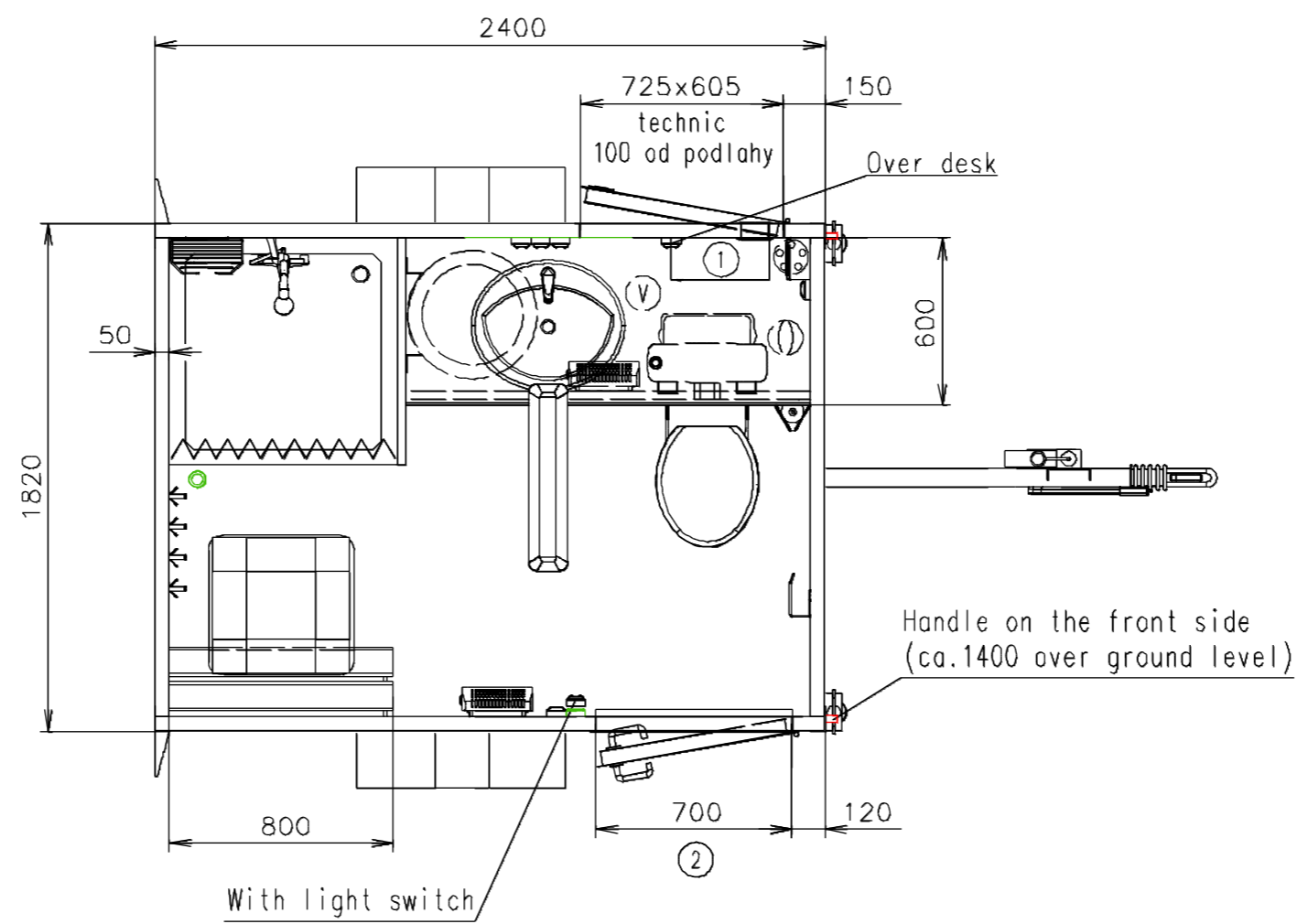

Notes:











Interior height:	2100 mm	Total weight:	750 kg
Color:	RAL 9010	Tare weight:	580 kg
Floor:	PVC black	Centre of wheels from rear side:	1100 mm
Date:	24.6.2015	Wheels:	165/70 R13

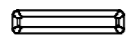

Drawing number:  
17-24-2\_1/2

(Cabling and piping is not shown on the 3D views and drawings)

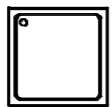
Connection hoses and cables	
Water hose:	✓
Waste water hose:	✓
Electric cable:	✓

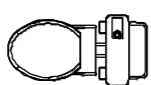
-  Water connection 3/4" (through the floor)
-  Electric connection (through the floor) (230V-16A)
-  Effluent connection 1"
-  Power point
-  Light switch
-  Switch board (500 over floor)
-  Draplight
-  Heating (500W)
-  Floor drain hole
-  Shower (800x800) Cola
-  Wash-basin (built-in) Multi 1690 (550x470) + standard water tap
-  Hanging toilet + pump Setson

-  Hot water boiler Gorenje (50 l)
-  Roof window Dometic (400x400)
-  Ventilation ø120
-  Wooden bench
-  Brush toilet
-  Toilet paper holder
-  Shelf steel
-  Shower curtain
-  Clothes hanger
-  Mirror (600x600)
- ① Sheet metal cupboard (over desk)
- ② Stairs Type 17

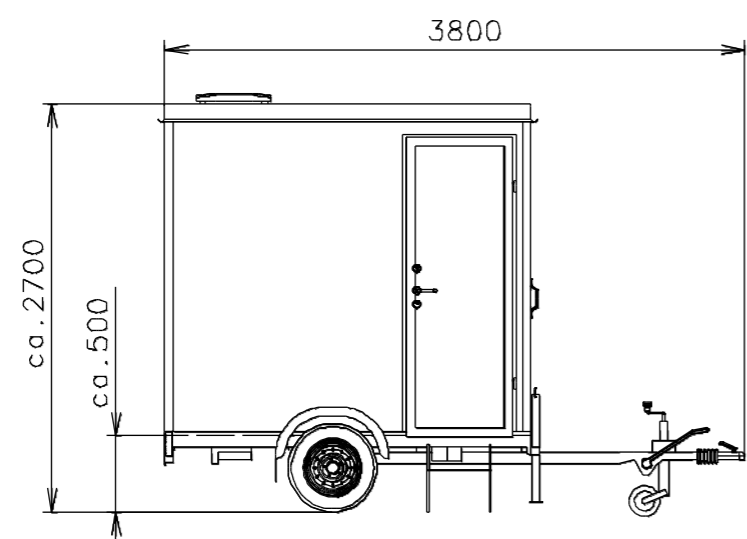

(Cabling and piping is not shown on the 3D views and drawings)

Notes:

Interior height:	2100 mm	Total weight:	750 kg
Color:	RAL 9010	Tare weight:	580 kg
Floor:	PVC black	Centre of wheels from rear side:	1100 mm
Date:	24.6.2015	Wheels:	165/70 R13



Drawing number:  
17-24-2\_2/2